

# USER MANUAL



BREASTPLATES &  
4-ANCHOR POINTS POSTURE BELT



## 1.0 TABLE OF CONTENTS

	<b>Page</b>
<b>1.0 Table of contents</b>	<b>3</b>
<b>2.0 Important considerations</b>	<b>4</b>
<b>3.0 User, clinician &amp; dealer satisfaction</b>	<b>5</b>
<b>4.0 Warranty &amp; limitation of liability</b>	<b>6</b>
<b>5.0 Guidelines with daily handling</b>	<b>7</b>
<b>6.0 The breastplate STARUS with FLEXUS</b>	<b>7</b>
<b>7.0 The breastplate STARUS with BACKUS &amp; CURVUS</b>	<b>8-9</b>
<b>8.0 The breastplate STARUS care and maintenance</b>	<b>10</b>
<b>9.0 The reversible 4-Anchor Points Posture Belt STARUS</b>	
<b>9.1 The back posture belt</b>	<b>12</b>
<b>9.2 The pelvic posture belt</b>	<b>13</b>
<b>10.0 The posture belt STARUS care and maintenance</b>	<b>14</b>



## 2.0 IMPORTANT CONSIDERATIONS



Positech innovation Inc. accepts no liability for personal injury or damage to property that may arise from the failure to follow the recommendations, warnings, and instructions in this **Installation & Care Manual**.



### **DEALERS / CLINICIAN :**

The respective product **User Manual** must be given to the consumer of any of Positech innovation Inc. products.

Before discharging the user with this product, review the entire **User Manual** with the user/caregiver. The **User Manual** must be saved by the user for future reference as it contains additional safety information related to the safe operation of all our products.

All persons responsible for fitting, adjustment, and daily use of the devices discussed in the **Instruction & Care Manual** must be familiar with and understand all safety aspects of the devices mentioned. In order for our products to be used successfully, you, Dealer & Clinician, must :

- Read and understand all instructions and warnings. If you are unable to understand these guidelines, contact Positech innovation Inc. for further instructions.
- Maintain our products according to our instructions on care and maintenance.
- Devices should be installed and adjusted **ONLY** by a trained qualified technician or clinician.
- Failure to adhere to instructions and warnings in this document may result in property damage, injury, or death.
- Product misuse due to failure of the following instructions will void the warranty.

Inform the User :

- To **NEVER** modify the set adjustments made you, Dealer & Clinician.
- To immediately discontinue use if any function is compromised, parts are missing, loose, or shows signs of excessive wear.

Consult with Positech innovation Inc. for repair, adjustment, or replacement.

A faulty usage of this product could worsen the user's condition instead of improving it.

Usage of this product for therapeutic purposes such as posture correction and support must be conducted in collaboration with a trained clinician.



### **DEALER/CLINICIAN :**

Check all parts for shipping damages before using. In case of damage, do **NOT** use the equipment. Contact Positech innovation Inc. for further instructions.

Monthly verifications are necessary to ensure that :

- Components are fastened securely.
- Adjustments remain adapted to the patient's condition evolution.
- Under the supervision of the clinician, further adjustments may be necessary in the event of a weight gain or loss, or an improvement or a worsening of the posture.



This **Installation & Care Manual** is compiled from the latest specifications and product information available at the time of publication. We reserve the right to make changes as they become necessary. Any changes to our products may cause slight variations between the illustrations and explanations in this manual and the product you have purchased. Information contained within this document is subject to change without notice.



You can download additional copies of this **Installation & Care Manual & User Manual** on the Positech innovation Inc. website.

## 3.0 USER, CLINICIAN & DEALER SATISFACTION

# You sit well with us.

Positech innovation Inc. strives for 100% customer satisfaction.

Your complete satisfaction is important to us.

Please contact us with feedback or suggestions that will enhance the quality and functionality of these products.

We can be reached at :

<b>Mail</b>	<b>100-1566 rue Nationale, Terrebonne, Québec, Canada J6W 0E2</b>
<b>Email</b>	<b>commande@positech.ca</b>
<b>Website</b>	<b>www.positechinnovation.com</b>
<b>Phone</b>	<b>(1) 450 964 3232</b>
<b>Toll Free</b>	<b>(1) 877 964 3232</b>
<b>Fax</b>	<b>(1) 450 964 3378</b>
<b>Customer Service Hours</b>	<b>Monday through Friday – 8h00 to 17h00 Eastern Standard Time ( EST )</b>

### FOR YOUR RECORD

<b>INSTALLATION DATE</b>		<b>CLINIC/HEALTHCARE CENTRE/PRACTICE</b>	
<b>USER INFORMATION</b>  NAME:  EMAIL/PHONE:  FILE #:		<b>DEALER STAMP</b>	
		<b>SERIAL NUMBER (if applicable)</b>	

## 4.0 WARRANTY & LIMITATION OF LIABILITY

Metallic components of products purchased from Positech are warranted against defects in workmanship and material for a period of two (2) years from the date of delivery of the product to the first consumer.

Textile components of products purchased from Positech are warranted against defects in workmanship and material for a period of ninety (90) days from the date of delivery of the product to the first consumer.

Non-metallic and non-textile components of products purchased from Positech are warranted against defects in workmanship and material for a period of one (1) year from the date of delivery of the product to the first consumer.

Positech's obligations under this warranty are limited to replacing (transportation costs at the Dealer's expense) or repairing, at its option, any products which under normal and proper use and maintenance are proved to be defective to Positech, in its sole discretion, within the warranty period, provided that Positech has had the opportunity to inspect them.

This warranty is not transferable and only applies to the first consumer purchase through an authorized Positech dealer.

This warranty does not cover products or parts thereof which (i) normally wear out due to the general wear and tear of standard use, (ii) are modified, altered, inadequately stored or kept, or (iii) are not installed, adjusted, used or maintained in accordance with Positech's instructions. In addition to the foregoing, this warranty does not cover punctures, tears, or burns, exposure to moisture, exceeding the weight limit and <acts of nature> ( ex. Flood, Earthquake, Tornado, etc. ). Any substitutions of supplied hardware also void the warranty.

THE FOREGOING IS POSITECH'S SOLE WARRANTY, ALL OTHER WARRANTIES, EXPRESSED OR IMPLIED, INCLUDING WARRANTIES OF FITNESS FOR PURPOSE AND MERCHANTABILITY, ARE EXCLUDED AND DISCLAIMED TO THE FULL EXTENT PERMITTED BY LAW. IN NO EVENT SHALL THE DEALER BE ENTITLED TO MORE THAN THE PRICE OF THE PURCHASED PRODUCTS AT THAT TIME AS FINAL PENALTY AND DAMAGE. IN NO EVENT, WHETHER AS A RESULT OF CONTRACT, TORT, STRICT LIABILITY OR OTHERWISE, SHALL POSITECH BE LIABLE FOR SPECIAL, INCIDENTAL, CONSEQUENTIAL OR PUNITIVE DAMAGES, INCLUDING BUT NOT LIMITED TO, LOSS OF USE, PROFIT OR REVENUE.

The Dealer understands and agrees that the Positech's products may be dangerous and result in injury, worsening of the condition or damage to property if not used properly. Consequently, the Dealer shall inform the user that he/she must (i) comply with all specifications, instructions and other requirements provided by Positech with the products, on Positech's website, in manuals, data sheets, on labels or packaging, and the terms & conditions uniting parties before making use of the products, and (ii) use the products under the supervision of a therapist in the case of severe deformities or when used for therapeutic purposes.

The Dealer shall hold harmless, indemnify and defend Positech from and against any and all claims, demands, causes of action, suits or judgments (including costs, expenses and reasonable attorney fees incurred in connection therewith) for the injury to any person or for loss of or damage to property arising out of or in connection with the improper use of the products whether or not caused by Dealer's negligence and for any default hereunder.

The Dealer may have additional rights by law which may vary from one jurisdiction to another. Positech does not hereby intend to limit or exclude the rights of the Dealer beyond the limits allowed by law.

This warranty applies in CANADA only.

### WARRANTY SERVICE

To obtain service under this warranty, the warranty-eligible Product must be presented to the nearest Positech innovation Inc. authorized dealer. In Canada, warranty service may also be obtained by calling (877)964 3232, Monday through Friday 8h00 to 17h00 Eastern Standard Time. Owner is responsible for all costs associated with returning Product to Positech innovation Inc. for service. Where at its sole discretion Positech innovation Inc. deems Product eligible for warranty repair or replacement, Positech innovation Inc. will pay the shipping and handling associated with returning repaired or replaced Product to Owner. In instances where Positech innovation Inc. deems a returned product ineligible for warranty service, Positech innovation Inc. will, if possible, repair product for a reasonable charge that includes return shipping and handling.

## 5.0 GUIDELINES WITH DAILY HANDLING



**DO NOT MODIFY ANY OF THE ORIGINAL ADJUSTMENTS MADE BY YOUR PROFESSIONAL CLINICIAN, otherwise injury or damage may occur.**

**YOU MAY WITH CAUTION SECURED ANY SCREWS, BOLTS, NUTS THAT HAVE BECOME LOOSE USING THE INITIAL TORQUE SETTINGS.**

**CONTACT THE DEALER/CLINICIAN IF YOU HAVE ANY QUESTIONS OR CONCERNS.**

## 6.0 THE BREASTPLATE STARUS with FLEXUS

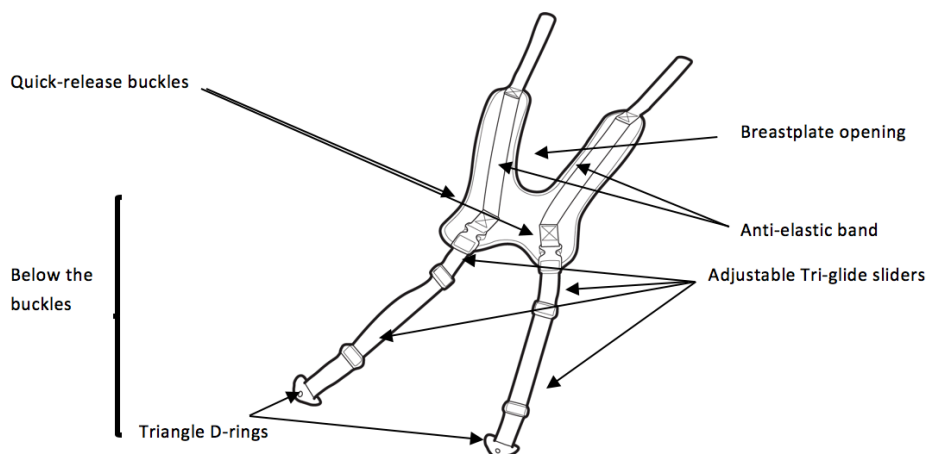

**WARNING :** The breastplate height must allow for proper neck clearance. There must be **AT LEAST 3 in. (7.5 cm)** between the opening of the breastplate and the base of the neck. The adjustment of the entire section below the quick-release buckles should never be modified, except by the clinician/technician.

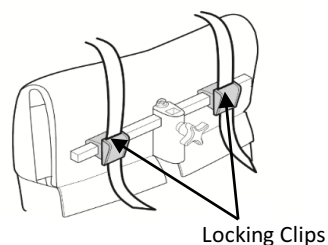
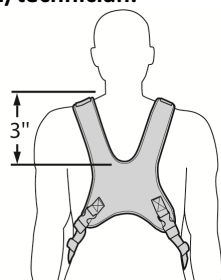

**To free-up the user, simply release the quick-release buckles and bring the breastplate above the head toward the back of the wheelchair. When sitting the user, all the lower adjustments will have remained. Simply buckle the mechanism to retrieve prior configurations or make it tighter/looser depending on clothing and comfort.**

<b>NOTES:</b>	<b>IN ORDER NOT TO COMPRESS THE TOP OF SHOULDER, VALIDATE THAT THE HEIGHT OF THE BACKREST IS OVERALL HIGHER.</b>
---------------	--

## 7.0 THE BREASTPLATE STARUS with BACKUS & CURVUS

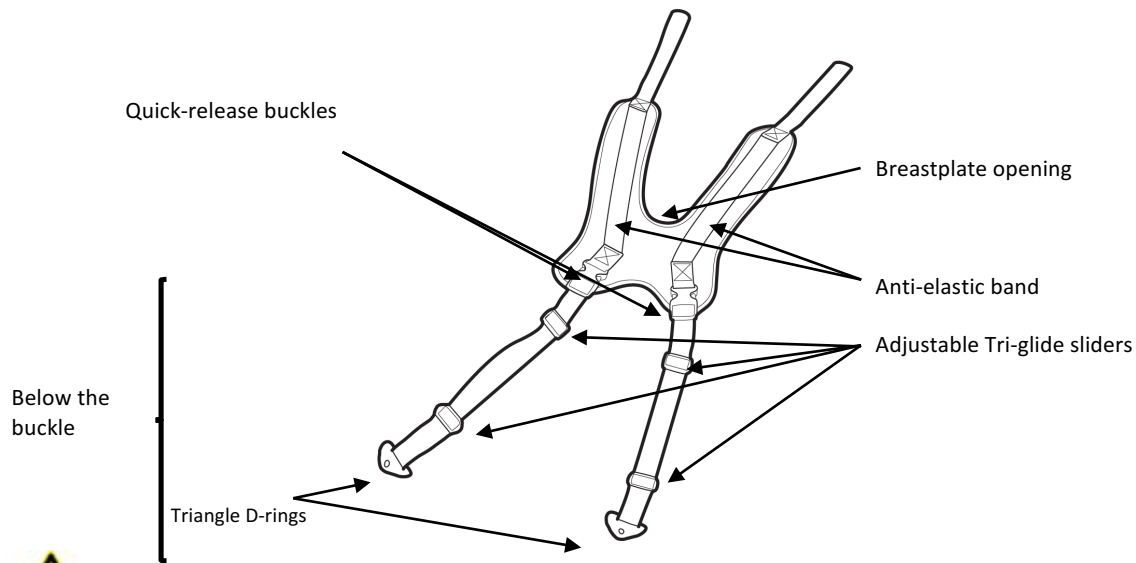

The breastplate height must allow for proper neck clearance. There must be **AT LEAST 3 in. (7.5 cm)** between the opening of the breastplate and the base of the neck. The adjustment of the entire section below the quick-release buckles should never be modified, except by the clinician/technician.

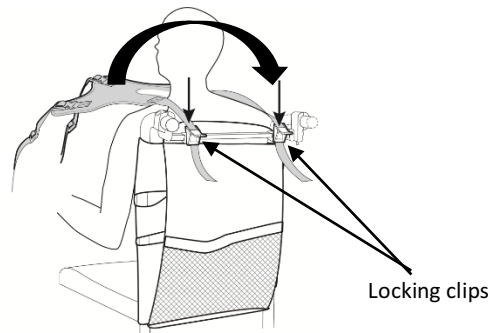
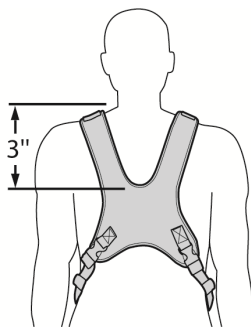

To free-up the user, simply release the quick-release buckles and bring the breastplate above the head toward the back of the wheelchair. When sitting the user, all the lower adjustments will have remained. Simply buckle the mechanism to retrieve prior configurations or make it tighter/looser depending on clothing and comfort.

NOTES:	IN ORDER NOT TO COMPRESS THE TOP OF SHOULDER, VALIDATE THAT THE HEIGHT OF THE BACKREST IS OVERALL HIGHER.
--------	---

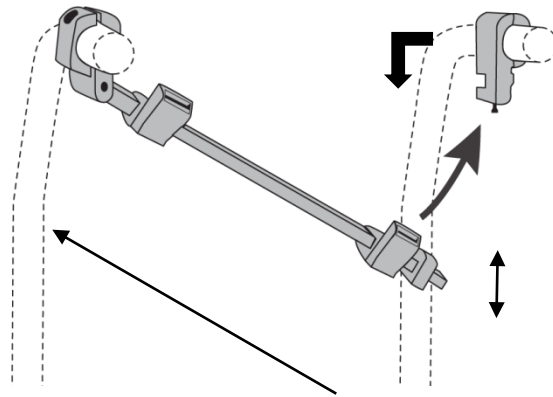

To fold the wheelchair, pull down the plunger, push forward and downward the mounting bar. It will come to a vertical position.

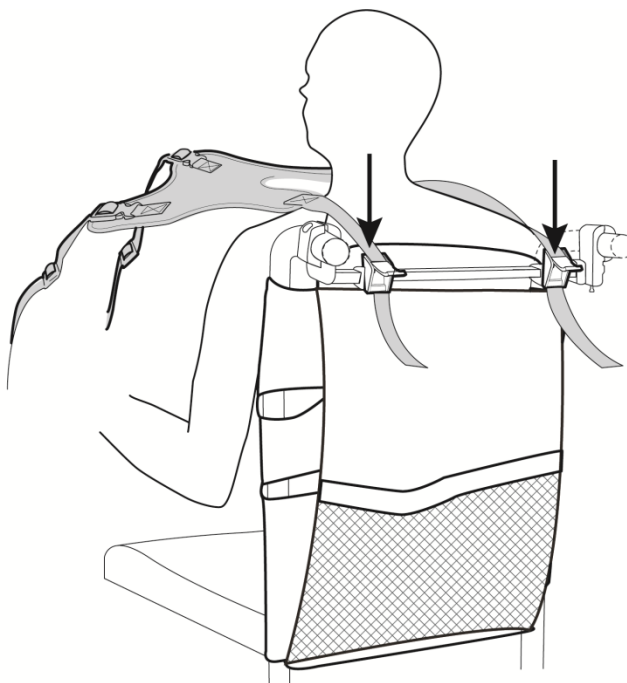

When it is time to sit user, reposition the mounting bar in a horizontal position and open the clips of both breastplate fasteners and insert upper straps through the clips.



**WARNING:**  
Ensure that you have freed up the required minimum 3” (7.5cm) space from the neck.

Close the clips.



## 8.0 THE BREASTPLATE STARUS CARE AND MAINTENANCE

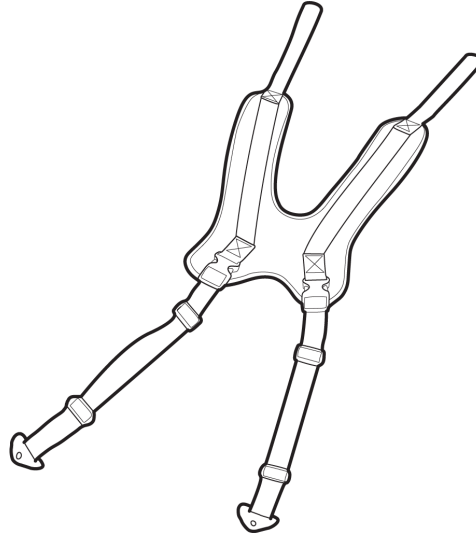

**WARNING :**

**DO NOT MACHINE DRY.**  
**DO NOT STEAM AUTOCLAVE.**  
**DO NOT DRY CLEAN.**  
**DO NOT USE BLEACH.**  
**DO NOT USE FABRIC SOFTENER.**

Free-up the upper part of the breastplate by opening the clips and the lower part by unlocking both quick-release buckles.

Hand wash the breastplate section in cold water with a mild detergent.

Dry flat.

Ensure that both sides are completely dry, then reassemble.

## 9.0 THE STARUS REVERSIBLE 4-ANCHOR POINTS POSTURE BELT

**NOTE:**

**THERE ARE TWO INSTALLATIONS OF THE STARUS POSTURE BELT POSSIBLE. BOTH PROVIDE THE USER WITH ADDITIONNAL SUPPORT FOR AN OPTIMAL POSTURE OF THE BACK OR THE PELVIS.**

**BACK POSTURE BELT**

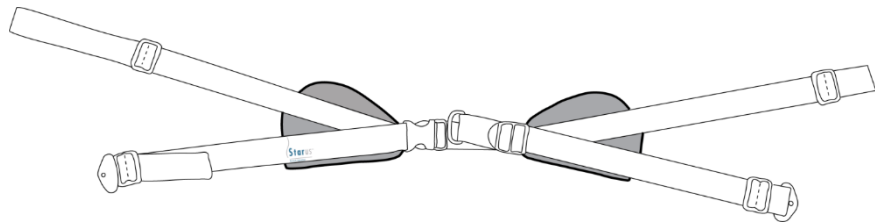

**ROTATION**

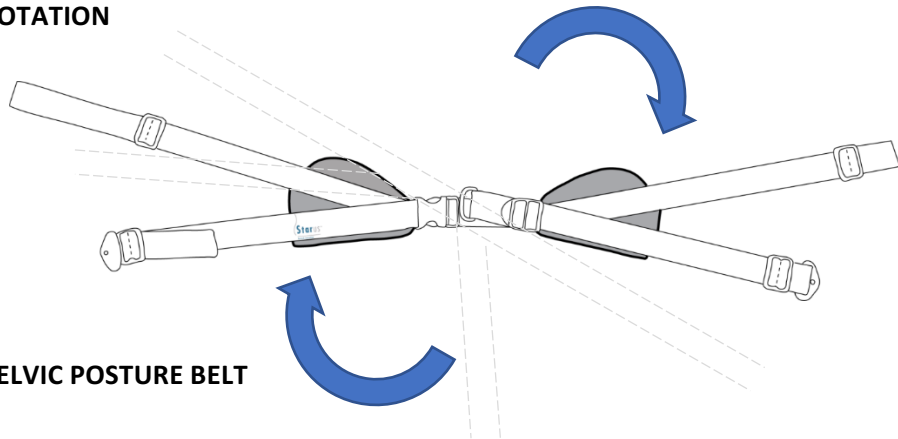

**PELVIC POSTURE BELT**

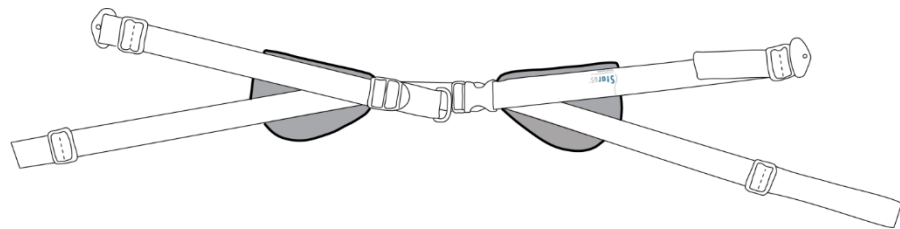

## 9.1 THE BACK POSTURE BELT

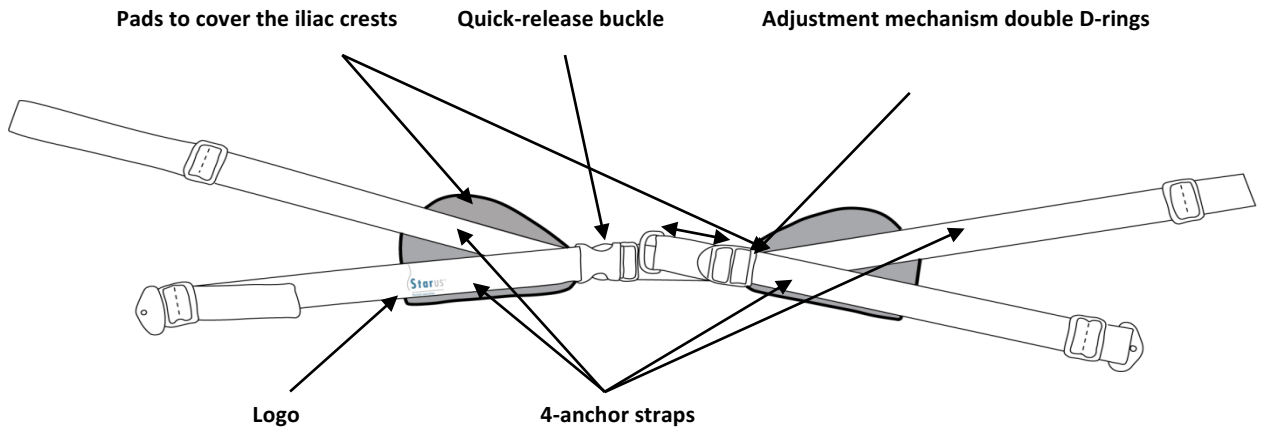

<b>NOTES :</b>	<p><b>USED TO BRING CLOSER THE USER'S BACK TO THE BACKREST CUSHION.</b></p> <p><b>WHEN FACING THE USER, THE <u>STARUS LOGO</u> IS LOCATED ON THE <u>RIGHT ILIAC CREST</u> OF THE USER.</b></p>
----------------	--

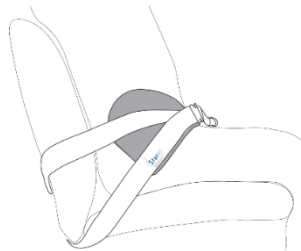

A 45° angle should be respected while assuring that the lateral pads remain flat on the iliac crests.

Fasten firmly.

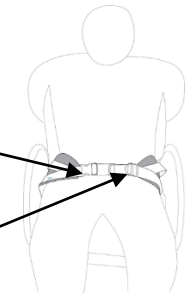
<b>NOTES :</b>	<p><b>USE ONLY THE QUICK-RELEASE BUCKLE TO UNLOCK THE BELT. THE SET CONFIGURATIONS WILL REMAIN AT ALL TIME.</b></p> <p><b>IF YOU NEED TO LOOSEN OR TIGHTEN THE BELT, EXTEND OR SHORTEN THE ADJUSTABLE STRAP LOCATED INTO THE D-RINGS TO MODIFY SETTINGS.</b></p>	 <p>Quick-release buckle</p> <p>Adjustable Strap into D-Rings</p>
----------------	--	--

## 9.2 THE PELVIC POSTURE BELT

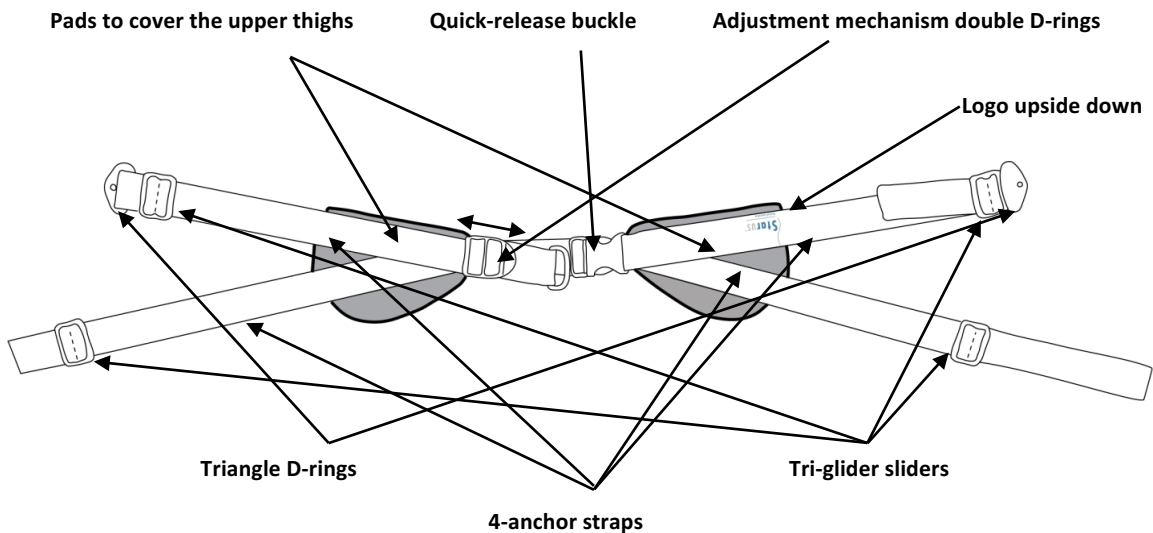

<b>NOTES :</b>	<p><b>USED TO BRING CLOSER THE USER'S PELVIC TO THE SEAT CUSHION.</b></p> <p><b>WHEN FACING THE USER, THE STARUS LOGO IS LOCATED <u>UPSIDEDOWN ON THE LEFT THIGH</u> OF THE USER.</b></p>
----------------	---

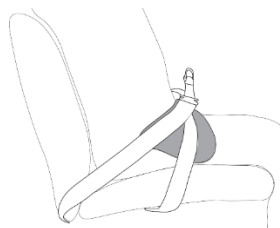

A 45° angle should be respected while assuring that the lateral pads remain flat on the upper portion of the thighs.

Fasten firmly.

<b>NOTES :</b>	<p><b>USE ONLY THE QUICK-RELEASE BUCKLE TO UNLOCK THE BELT. THE SET CONFIGURATIONS WILL REMAIN AT ALL TIME.</b></p> <p><b>IF YOU NEED TO LOOSEN OR TIGHTEN THE BELT, EXTEND OR SHORTEN THE ADJUSTABLE STRAP LOCATED INTO THE D-RINGS TO MODIFY SETTINGS.</b></p>	 <p>Quick-release Buckle</p> <p>Adjustable Strap into D-Rings</p>
----------------	--	--

## 10.0 THE STARUS POSTURE BELT CARE AND MAINTENANCE

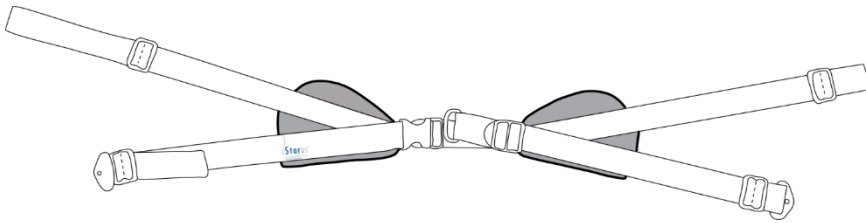

**WARNING :**

**DO NOT MACHINE DRY or SUN DRY**  
**DO NOT STEAM AUTOCLAVE.**  
**DO NOT DRY CLEAN.**  
**DO NOT USE BLEACH.**  
**DO NOT USE FABRIC SOFTENER.**

Disassemble from the wheelchair.

Hand wash in cold water with a mild detergent.

Dry flat.

Ensure that both sides are completely dry, then reassemble with the help of the clinician/technician.



CORPORATE HEADQUARTERS

100-1566 rue Nationale,  
Terrebonne, Québec, Canada  
J6W 0E2

TEL: 1 450-964-6262  
1 877-964-3232  
FAX: 1 450-964-3378

[www.positechinnovation.com](http://www.positechinnovation.com)  
[commande@positech.ca](mailto:commande@positech.ca)